

DN9848

Loudspeaker Processor

OPERATORS MANUAL

Software Version 3.02

Telex Communications (UK) Limited,
Klark Teknik Building,
Walter Nash Road,
Kidderminster.
Worcestershire.
DY11 7HJ.
England.

Tel: +44 (0) 1562 741515
Fax: +44 (0) 1562 745371

Email: sales@ktgplc.com
Website: www.klarkteknik.com

DN9848 Loudspeaker Processor Operators Manual
DOC02-DN9848 Issue 2.0 - January 2005
(c) Telex Communications (UK) Limited.

In line with the company's policy of continual improvement, specifications and function may be subject to change without notice. This Operators Manual was correct at the time of writing. E&OE.

IMPORTANT SAFETY INSTRUCTIONS



These symbols are internationally accepted symbols that warn of potential hazards with electrical products.



The lightning flash with arrowhead symbol, within an equilateral triangle is intended to alert the user to the presence of uninsulated "dangerous voltage" within the product's enclosure that may be of sufficient magnitude to constitute a risk of electric shock to persons.



The exclamation point within an equilateral triangle is intended to alert the user to the presence of important operating and maintenance (servicing) instructions in the literature accompanying the appliance.

1. Read these instructions.
2. Keep these instructions.
3. Heed all warnings.
4. Follow all instructions.
5. Do not use this apparatus near water.
6. Clean only with a dry cloth.
7. Do not block any of the ventilation openings. Install in accordance with the manufacturers instructions.
8. Do not install near any heat sources such as radiators, heat registers, stoves, or other apparatus (including amplifiers) that produce heat.
9. Do not defeat the safety purpose of the polarized or grounding-type plug. A polarized plug has two blades with one wider than the other. A grounding type plug has two blades and a third grounding prong. The wide blade or the third prong are provided for your safety. If the provided plug does not fit into your outlet, consult an electrician for replacement of the obsolete outlet.
10. Protect the power cord from being walked on or pinched particularly at plugs, convenience receptacles, and the point where they exit from the apparatus.
11. Only use attachments / accessories specified by the manufacturer.
12. Unplug this apparatus during lightning storms or when unused for long periods of time.
13. Refer all servicing to qualified personnel. Servicing is required when the apparatus has been damaged in any way, such as power-supply cord or plug is damaged, liquid has been spilled or objects have fallen into the apparatus, the apparatus has been exposed to rain or moisture, does not operate normally, or has been dropped.



Telex Communications (UK) Limited, Klark Teknik Building,
 Walter Nash Road, Kidderminster. Worcs. DY11 7HJ. England.
 Tel: +44 1562 741515 Fax: +44 1562 745371
 www.midasconsoles.com www.klarkteknik.com

DECLARATION OF CONFORMITY

We, **Telex Communications (UK) Limited**

of, Klark Teknik Building, Walter Nash Road, Kidderminster, Worcestershire, DY11 7HJ.

Declare that a sample of the following product:-

Product Type Number	Product Description	Nominal Voltage(s)	Current	Freq
DN9848	Loudspeaker Processor	115V AC 230V AC	200mA 100mA	50/60Hz

to which this declaration refers, is in conformity with the following directives and/or standards:-

Directive(s)	Test Standard(s)
89/336/EEC Electromagnetic Compatibility Directive amended by 92/31/EEC & 93/68/EEC 73/23/EEC, Low Voltage Directive, amended by 93/68/EEC	
Generic Standard Using EN55103 Limits and Methods	EN50081/1
Class B Conducted Emissions PAVI	EN55103
Class B Radiated Emissions PAVI	EN55103
Fast Transient Bursts at 2kV	EN61000-4-4
Static Discharge at 4kV	EN61000-4-2
Electrical Stress Test	EN60204
Electrical Safety	UL6500-99
	CAN/CSA E60065-00

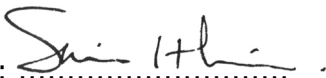
Signed: 
 Name: Simon Harrison

Date: 1st January 2005

Authority: Research and Development Director, Telex Communications (UK) Limited

Attention!

Where applicable, the attention of the specifier, purchaser, installer or user is drawn to special limitations of use which must be observed when these products are taken into service to maintain compliance with the above directives. Details of these special measures and limitations to use are available on request and are available in product manuals.

Thank You For Using This Klark Teknik Product

Our engineers have designed this product with uncompromising dedication to providing the superb audio performance, ease of use and rugged reliability that meets the demands of live sound engineering.

Please take time to complete and return the Klark Teknik three-year warranty registration card and, to obtain maximum performance with minimum effort, refer to this operators manual. Please ensure that you read both the Important Safety Instructions and Attention! pages.

Finally, enjoy your new DN9848!

CONTENTS

ATTENTION!	1
1. INTRODUCING THE DN9848	3
2. FRONT PANEL	4
3. REAR PANEL	5
4. PROGRAMMING SETTINGS	6
4.1. The DN9848 Programming Panel	6
4.2. Navigating the DN9848 Menus	6
4.2.1 Input and Output Menus	6
4.2.2 Set Up Menu	7
4.2.3 Store and Recall.....	7
4.2.4 Home Page	7
5. INPUT CHANNELS	9
5.1. Brief Technical Overview	9
5.2. Setting Input Parameters	9
5.2.1 The Input Menu	9
5.2.2 Naming the Input Channel (Page 1)	9
5.2.3 Gain and Delay (Page 1)	10
5.2.4 Parametric Equalisation (Pages 2 to 13)	10
5.2.5 Compression (Page 14)	11
5.3. Monitoring the Input Signal	11
6. OUTPUT CHANNELS	12
6.1. Brief Technical Overview	12
6.2. Setting Output Parameters	13
6.2.2 Naming the Output Channel (Page 1)	13
6.2.3 Routing (Page 2)	13
6.2.4 Signal Invert, Delay and Output Level (Page 3)	14
6.2.5 Phase Adjustment (Pages 4 and 5)	14
6.2.6 High Pass and Low Pass Filters (Pages 6 and 7)	15
6.2.7 Parametric Equalisation (Pages 2 to 13)	16
6.2.8 Compression (Page 14)	16

6.2.9	Output Limiter	17
6.3.	Monitoring the Output Signal.....	17
6.4.	Output Gain and Mute - Front Panel Control	18
7.	DN9848 SET UP OPTIONS	19
7.1.	General.....	19
7.2.	Remote Comms Channel (Page 1).....	19
7.3.	Security Settings (Pages 2 and 3).....	19
7.3.1	Front Panel Lock (Page 2).....	19
7.3.2	System Protect (Page 3).....	20
7.4.	LCD Lighting (Page 4)	21
7.5.	Naming (Pages 5 and 6).....	21
7.6.	Delay Options (Page 7)	22
7.7.	Power Up Options (Page 8).....	22
8.	STORING AND RECALLING SETTINGS	23
9.	DN9848 REMOTE CONTROL SETUP	25
10.	APPLICATION NOTES	27
10.1.	The Advantage of DN9848 Look-Ahead Limiters	27
10.2.	Phase-adjustment with the DN9848	29
11.	TECHNICAL SPECIFICATION	31



Please ensure that you read and follow the IMPORTANT SAFETY INSTRUCTIONS at the front of this manual and the SAFETY WARNINGS and INSTALLATION CONSIDERATIONS given below.

Safety Warning

To prevent shock or fire hazard, do not expose the unit to rain or moisture. To avoid electrical shock do not remove covers. Refer servicing to qualified personnel only.

This unit is fitted with a standard fused IEC mains power socket. The unit contains a switch mode power supply that automatically adjusts itself to 50/60Hz mains supplies in the 100 V to 240 V (+/- 10%) AC range. This information is printed on the rear of the unit, below the mains inlet socket.

Before connecting this unit to the mains supply, ensure that the fuse fitted is the correct type and rating as indicated on the rear panel.

For safety reasons the mains earth lead should never be disconnected. In the event of ground loop problems, disconnect the signal screen at one end of the connecting cables – note that this can only be done when the unit is used within a balanced system.

Installation Considerations

- Location:** Do not install this unit in a location subjected to excessive heat, dust or mechanical vibration. Allow for adequate ventilation around the unit, making sure the unit's fans and vents are not obstructed. To prevent excessive heating of the unit, avoid mounting the unit directly above power amplifiers or other devices that radiate significant amounts of heat. Where necessary use fan cooled racks.
- Cables:** To ensure correct and reliable performance, this product should only be used with high quality, screened twisted pair audio cables, terminated with metal bodied 3-pin XLR connectors (Pin 2 Hot).
- Electric Fields:** Should this product be used in an electromagnetic field that is amplitude modulated by an audio frequency signal (20Hz to 20kHz), the signal to noise ratio may be degraded. Degradation of up to 60dB at a frequency corresponding to the modulation signal may be experienced under extreme conditions (3V/m, 90% modulation).

After Unpacking

Please retain the original packing for use should you need to transport or ship this unit.

Please inspect the unit carefully for any signs of damage that may have occurred in transit and notify the courier immediately if you feel that any damage has occurred.



1. INTRODUCING THE DN9848

The DN9848 is a highly configurable, digital electronic cross-over/loudspeaker management system comprising four balanced analogue input channels and eight balanced analogue output channels. Its unrivalled routing flexibility enables each output to be sourced from a single input, a pair of inputs, or all four inputs.

Each input channel features:

- ▣ 12 separately configurable, fully parametric equalisation stages that may be used for room equalisation
- ▣ A programmable delay of up to 1000ms
- ▣ Gain control
- ▣ Full range compression

Each output channel features:

- ▣ Configurable high and low-pass filters for setting the cross-over characteristics
- ▣ Six stages of fully parametric equalisation that may be used to compensate for system or enclosure characteristics
- ▣ Delay of up to 300ms on each output, mainly used for system time alignment
- ▣ Gain control and output muting
- ▣ Full range compression and full range limiting
- ▣ Dual all-pass phase correction sections, the first of which can be any of the filter or parametric EQ stages and can be adjustable in 5 degree steps

The cross-over filter may be chosen from the following types:

- ▣ 12dB/oct and 24dB/oct peaking (high-pass filter only)
- ▣ Butterworth (6, 12, 18, 24, 36 and 48dB/octave)
- ▣ Linkwitz-Riley (12 and 24dB/octave)
- ▣ Bessel (12, 18, 24, 36 and 48dB/octave)

Channel programming can be performed directly from the front panel controls or remotely using the associated Stardraw software application or Smaart real-time analysis software (via the RS-232 PC Port or RS-485 COMMS connectors). If required, access to critical parameter menus can be password protected, e.g. to avoid unauthorised adjustments in hire installations.

Commonly used settings can be stored for repetitive use in up to 32 lockable System memories while varying show settings can be stored in up to 5 User memories. Also 99 Presets can be stored in non-volatile Flash memory, including up to 25 available Factory Preset cross-over set ups for commonly used Electro-Voice loudspeaker systems.

Klark Teknik has a policy of continuous development and may produce updates to the DN9848 host code. These can be downloaded to the unit via the front panel PC Port. To keep up with newest features and functions, please visit www.klarktechnik.com.



2. FRONT PANEL

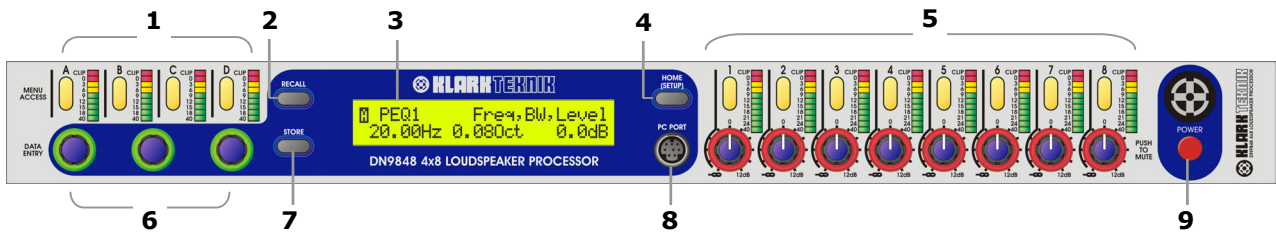

1 Input channels A-D



Menu Access Buttons A-D

Press to access and step through the menu pages for the respective input. The available pages depend on the current security setting. The button is lit when active.

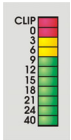

Signal Level Meters A - D

9-segment signal meters for monitoring signal level (compressor headroom and gain reduction) and clip on the respective channels.

2 Recall button

Press to access the Recall menu page from which a User, System or Preset memory can be selected for recall.

3 Alphanumeric display

Displays menu pages for viewing/defining parameter values. Values are adjusted via the DATA ENTRY encoders knobs.

4 Home (Set Up) button

Press to exit current menu page and return to default Home page. Press and hold for 1 second to access Set Up menu, then press to step through Set Up pages.

5 Output channels 1 - 8



Menu Access Buttons 1-8

As for input channels.

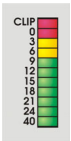

Signal Level Meters 1 - 8

11-segment clip signal meters for monitoring signal level (compressor/limiter headroom and gain reduction) and clip on the respective channels.



Output level and mute control

Potentiometer control for fine-tuning/muting of output level. Zero level refers to the level set in the output menu. Turn control to increase/decrease level or press to mute. Red ring lights when mute is active.

6 Data entry encoder knobs

Used to set parameter values on menu pages (see Section 4.1).

7 Store button

Press to access the Store menu page for storing User or System memories.

8 PC port

8-pin mini-DIN socket for connecting to an RS-232 serial port on a PC or other remote control device. (XLR connector is provided on the rear panel for remote control via RS-485.)

9 Power button

Press to switch the unit on or off.



3. REAR PANEL

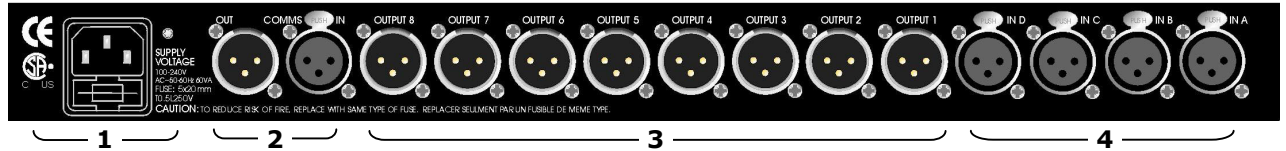

1 IEC fused mains inlet socket

For mains power connection. Accepts input voltages from 100-240V AC 50/60Hz.

2 COMMS In and Out

Communications input and output for remote control using XLR cabling.

3 Outputs 1-8

Electronically balanced XLR audio output plugs

Pinouts: Pin 1 Screen
Pin 2 Hot
Pin 3 Return

4 Inputs A-D

Electronically balanced XLR audio input sockets

Pinouts: Pin 1 Screen
Pin 2 Hot
Pin 3 Return



4. PROGRAMMING SETTINGS

4.1. The DN9848 Programming Panel

All the parameters for input and output signal processing and routing are defined via function specific menu pages that are displayed and edited at the programming panel shown below. As described in the illustration, each menu page uses a standard layout that relates the displayed parameters to the three DATA ENTRY encoder knobs, which are used to adjust the parameter values.

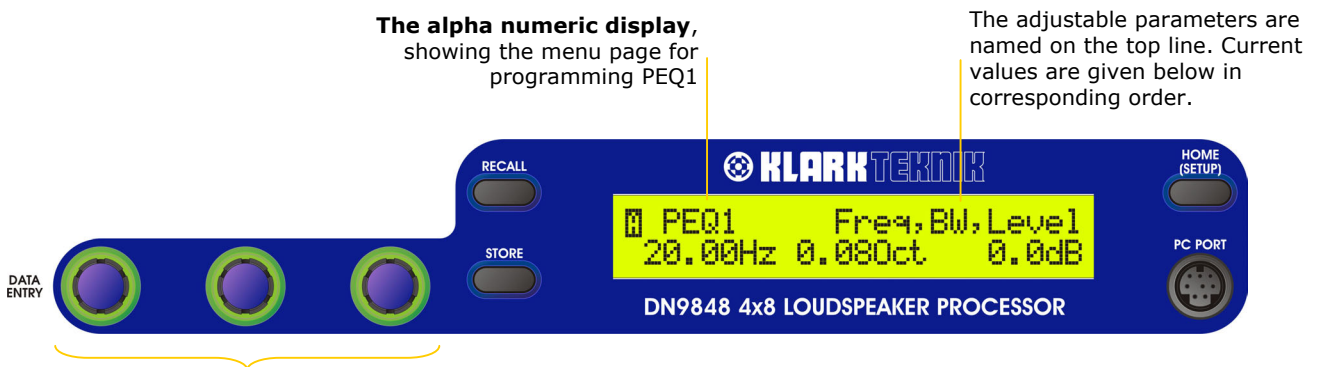

The DATA ENTRY encoder knobs adjust the left, centre and right parameter values at the display, in corresponding order. If there are only one or two parameters, only the active controls are lit.

When the menu page requires text entry, '<>' indicates which knob moves the cursor left and right while 'chr' indicates which knob changes the alpha numeric character.

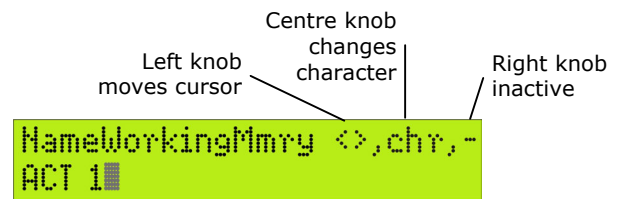

When there are sub-menu pages either the left or right knob will be allocated to moving forward (-->) or back up (<--). This will be indicated here by a knob icon marked L (Left) or R (Right).

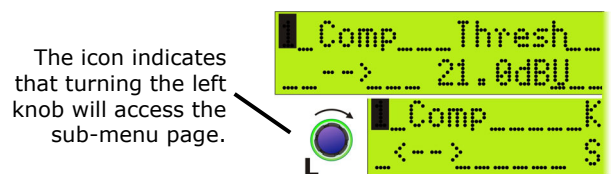

4.2. Navigating the DN9848 Menus

The DN9848 menu system is divided logically into Input, Output and Set Up menus, plus two function specific menus for quick access to the Store and Recall commands. A menu map is provided at the end of this section for reference purposes.

4.2.1 Input and Output Menus

Each of the four input channels (A-D) and eight output channels (1-8) has their own set of menu pages, accessed and stepped through by pressing the channel's yellow MENU ACCESS button. When you select a channel, its button lights to show that this channel is currently active at the programming panel. In addition, all the menu pages show the channel number/letter in the top left-hand corner.



If you prefer to program each parameter in turn across all the input/output channels, you can also skip across from the current channel to the same page on another input/output channel by pressing the **MENU ACCESS** button of the other channel. If you want to jump to the first page of a different channel, press the **HOME** button and then the required channel button.

4.2.2 Set Up Menu

Global parameters, such as the Comms Channel for remote control set ups, security options and unit labelling are defined in the Set Up menu. To switch to the Set Up menu, press and hold the black **HOME (SET UP)** button located on the programming panel. Press the button repeatedly to cycle through the menu pages.

4.2.3 Store and Recall

The Store and Recall menu pages are accessed by the corresponding buttons on the programming panel. To abort and exit the store/recall menu press the **HOME** button.

4.2.4 Home Page

The Home page, displayed at the end of the start up routine, indicates the unit name (set by the User) and the current working memory which was retained from the previous session. To return to the Home page at any time, press and release the **HOME** button. (The **HOME** button is a dual function button – a short press returns to the Home page while a long press opens the Set Up menu.) The **HOME** button can also be pressed to abort a Store or Recall process.

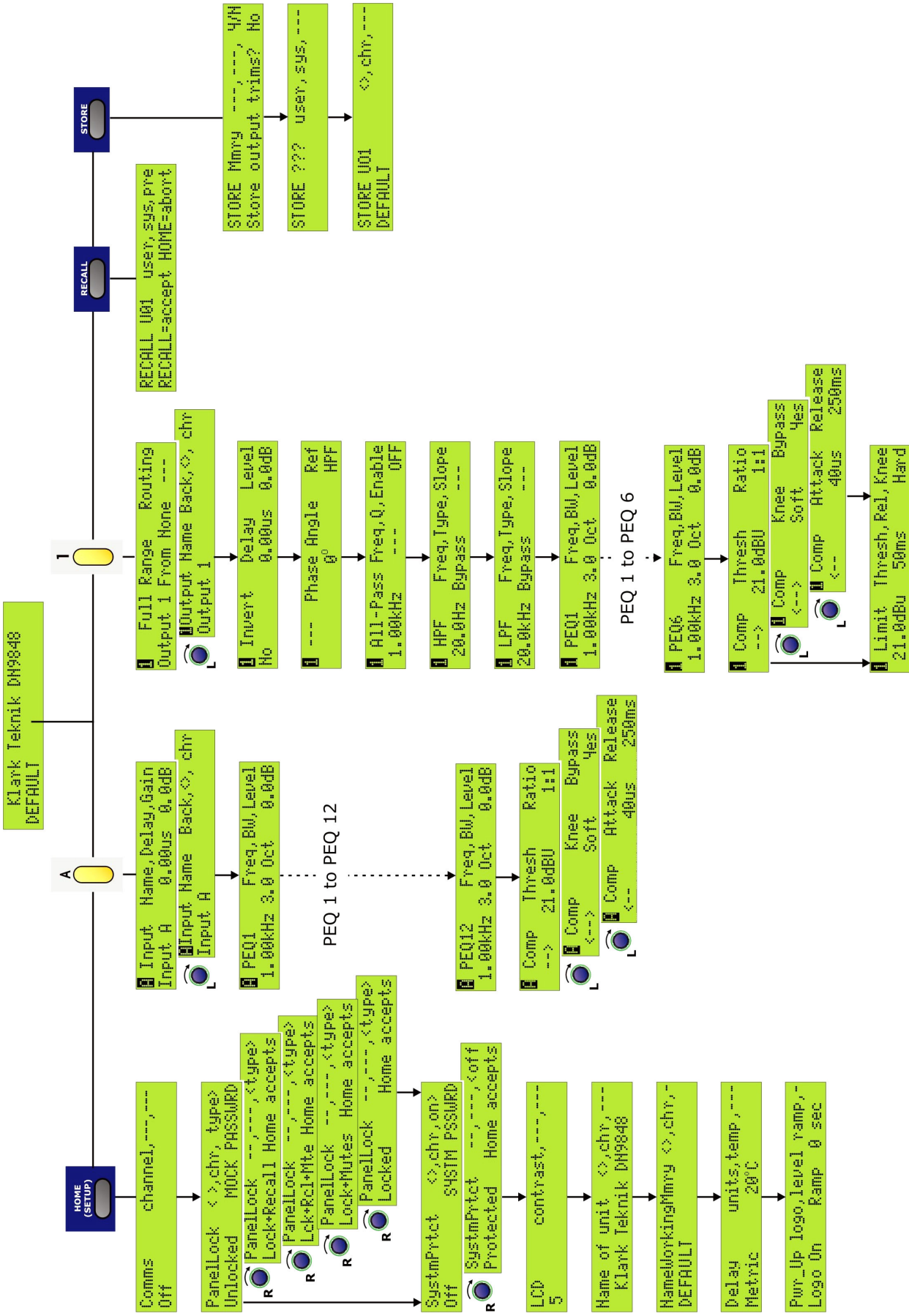



5. INPUT CHANNELS

5.1. Brief Technical Overview

Referring to the illustration below, each input channel of the DN9848 processes the audio signal through delay and gain stages, followed by 12 bands of parametric equalisation, and a full-band compressor. All key stages are monitored for signal clipping which, if detected, lights the top red segment at the top of the input signal meter; thus clipping of the signal during processing is not inadvertently missed. In addition, the signal level is monitored at the compressor to provide signal head room and gain reduction indications at the meter.

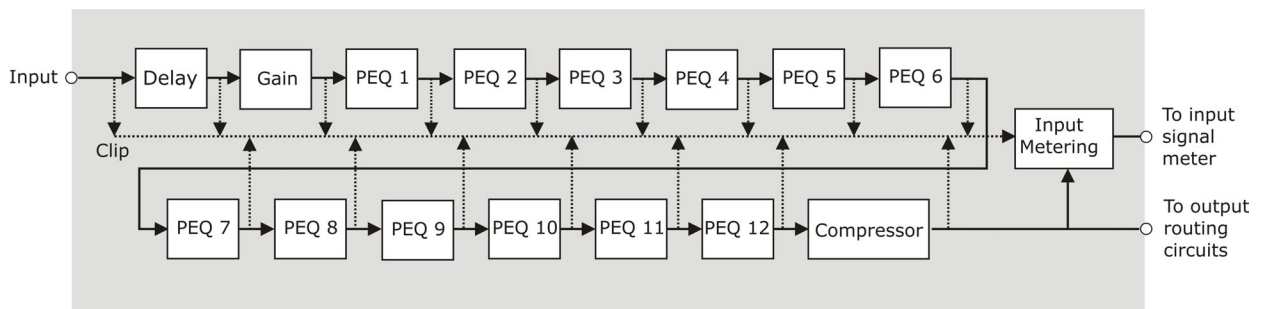

5.2. Setting Input Parameters

5.2.1 The Input Menu

The signal processing for each input channel is programmed independently via the separate Input menu associated with each channel. The signal processing parameters are described below in menu order.

▶▶ **To access the Input menu pages for a particular channel**

- 1 Press its yellow **MENU ACCESS** button (A – D) to switch to its menu.
- 2 Press the button repeatedly to step through the pages in turn. Note that, after the last page, the next button press will cycle the menu back to the first page.

▶▶ **To skip across to the same parameter on another input, press its MENU ACCESS button.**

5.2.2 Naming the Input Channel (Page 1)

Each input channel can be allocated a name up to 7 characters long, which will be shown in the first page of the menu for easy reference. The default names are Input A, Input B, etc. Names are retained after power down and are included in stored settings.

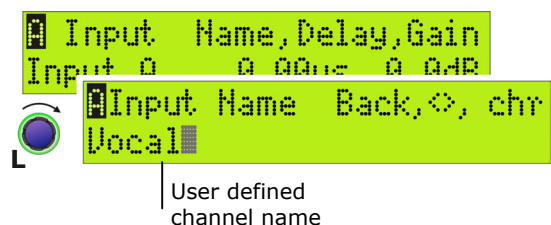

▶▶ **To enter a name**

- 1 Turn the left-hand knob clockwise to access the Input Name sub-menu page.
- 2 Use the centre knob to move the cursor right or left, and the right-hand knob to select the letter, number or symbol.
- 3 On completion, turn the left-hand knob anti-clockwise to go back to the main page. The new name is now shown to the left of the menu page.



5.2.3 Gain and Delay (Page 1)

Gain and delay are also set in the first page of the channel's menu, providing easy access for quick adjustment during set up or performance. Note that the delay can be specified in terms of time or distance, as preferred. The unit of measurement is changed in the Set Up menu (see Section 7.6).

```
Input Name, Delay, Gain
Input A      0.000s  0.0dB
```

Delays can be set in seconds, metres, or feet.

▶▶ To set the delay

- Turn the centre knob slowly for step increments, or sharply to leap to the bottom/top of the range (2 or 3 sharp turns will cover the whole range). The range is 0 to 1ms in steps of 20.83 μ s and 1ms to 1s in steps of 0.02ms, or the equivalent in metres or feet.

▶▶ To adjust the gain

- Turn the right-hand knob. The range is -40dB to +12dB in steps of 0.1dB, with an OFF position just 'below' -40dB. Setting the gain to OFF will mute the input signal.

5.2.4 Parametric Equalisation (Pages 2 to 13)

The DN9848 provides 12 parametric equalisation stages on each input channel, for equalising the input signal in respect of room/venue characteristics. Each stage can be used across the full range from 20Hz to 20kHz and is set independently via its own menu page.

```
PEQ1      Freq, BW, Level
1.00kHz  3.0 Oct  0.0dB
```

▶▶ To set a PEQ

- 1 Set a centre frequency (21 steps per octave) and bandwidth (0.08 to 3 Oct) for the PEQ section, using the left and centre knobs, respectively.
- 2 Turn the right-hand knob to set an attention/boost level in the range -18dB to +6dB.

PEQ sections which are not needed in the set up should be set to 0dB attention/boost.



5.2.5 Compression (Page 14)

Each input has an independent full-range compressor to improve the dynamics of the incoming signal levels. The compressors are variable ratio and can be set to a hard knee characteristic for a sharp gain reduction response at the compression threshold, or soft knee for a more 'musical' response.



►► To set the compressor parameters

- 1 On the first compressor menu page, use the centre knob to select a threshold value in the range -10dB to +21dB, and the right-hand knob to set a ratio from 1:1 to 5:1.
- 2 Turn the left-hand knob clockwise to access the first sub-menu page. Use the centre knob to select a hard or soft knee characteristic and the right-hand knob to set the bypass state to 'No' so that the compressor is included in the signal path.
- 3 Turn the left-hand knob clockwise to access the second sub-menu page. Use the centre knob to set the compressor attack time (range of 40µs – 1ms in 20µs steps or 1ms to 100ms in 1ms steps). Use the right-hand knob to set the release time (10ms to 2s in 10ms steps).

►► To switch the compressor out of the circuit

- Set the bypass state on the second compressor page to 'Yes'. The other settings are held for future use.

5.3. Monitoring the Input Signal

Each of the four inputs has a 9-segment signal meter for monitoring the internal signal clipping and compressor headroom or gain reduction.

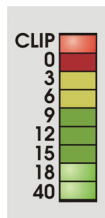

The top CLIP segment monitors the internal signal clipping. It operates independently of the rest of the meter, lighting when signal clipping is detected at any stage in the processing circuits, regardless of whether the input level is above or below the compressor and/or limiter thresholds. Hence, the audio engineer has full visibility of internal signal clipping that may result in audio distortion.

The 0 to -40 signal meter monitors the input level on a relative scale, where the 0 segment is set at the specified compressor threshold. For example, if the threshold is set to +9dBu then the input signal meter 0 segment is set at 9dBu true value, and a signal of -3dBu registers as 12dBu below the threshold (below left). Thus, when the signal level is below the threshold, the meter indicates the headroom.

When the signal level reaches the threshold, i.e. the red 0 segment lights, the meter 'flips' and reads downwards to show the amount of gain reduction applied to the signal.

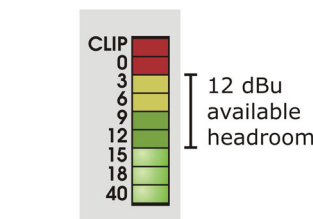

Signal level below compressor threshold

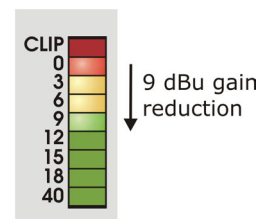

Compressor threshold reached



6. OUTPUT CHANNELS

6.1. Brief Technical Overview

The output channels are slightly more complex than the input channels in that they are responsible for the signal routing as well as output signal processing. At the input of each output channel is a routing block that can source the output signal from a single input, a pair of inputs, or all four inputs. In addition, as shown below, the paired inputs can be weighted (default 50:50).

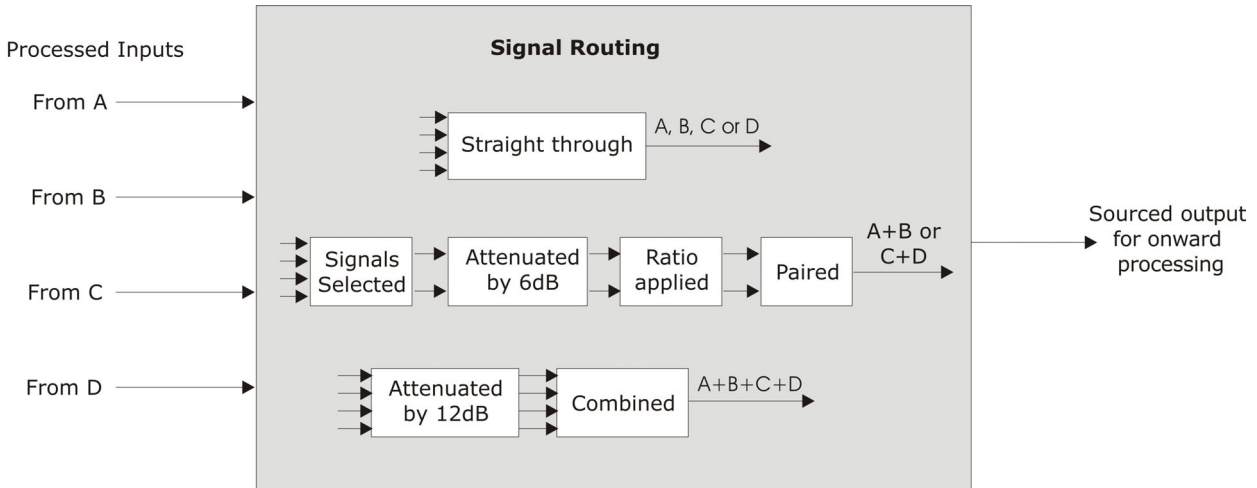

After routing, the resultant signal is passed through the various output processing circuits as shown below. Processing options include delay, inversion, two independent phase adjustment stages (Phase Shift and All Pass), filtering, six stages of parametric equalisation, gain/mute, compression and limiting. All key stages are monitored for signal clipping which, if detected, lights the top red segment at the top of the output signal meter. In addition, the signal is monitored through the compressor and limiter stages to provide headroom/gain reduction indications at the signal meter.

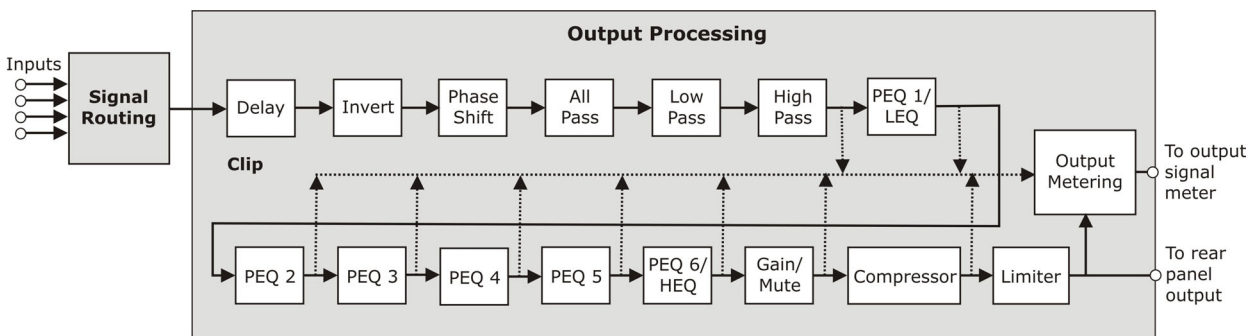



6.2. Setting Output Parameters

Signal processing for each output channel is programmed independently via the separate Output menu associated with each channel. The signal processing parameters are described below in menu order.

▶▶ To access the Output menu pages for a particular channel

- Press its yellow **MENU ACCESS** button (1 – 8) to switch to its menu.
- Press the button repeatedly to step through the pages in turn. Note that, after the last page, the next button press will cycle the menu back to the first page.

▶▶ To skip across to the same parameter on another output, press its **MENU ACCESS** button.

6.2.2 Naming the Output Channel (Page 1)

Each output channel can be allocated a name up to 8 characters long, which will be shown in the first page of the menu for easy reference. The default names are Output 1, Output 2, etc. Names are retained after power down and are included in stored settings.

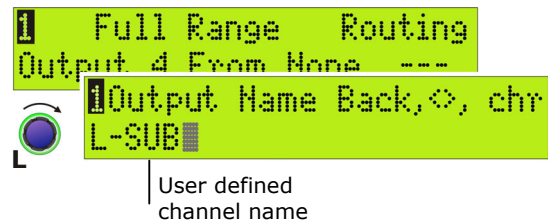

▶▶ To enter a name

- 1 Turn the left-hand knob clockwise to access the Output Name menu page.
- 2 Use the centre knob to move the cursor right or left, and the right-hand knob to select the letter, number or symbol.
- 3 On completion, turn the left-hand knob anti-clockwise to go back to the main page. The new name is now shown to the left of the menu page.

6.2.3 Routing (Page 2)

Each output of the DN9848 can be acquired from a single input, a pair of outputs or all outputs. For paired outputs, the source inputs are attenuated by 6dB prior to summing and the ratio of the two signals used is adjustable. When all outputs are combined, the source inputs are attenuated by 12dB prior to summing in equal proportion. (See Section 6.1 for Technical Overview).

For easy access and reference purposes, the routing is selected in the first menu page as shown opposite.

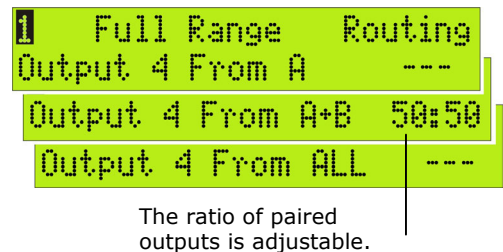

▶▶ To set the routing for the output

- 1 Turn the centre knob to select the required source from the following sequence of choices: A, B, C, D, A+B, C+D, All.
- 2 If you select A+B or C+D, use the right-hand knob to set the ratio for the signals, i.e. A:B or C:D, respectively.

Important! Delays for the summed channels must be set to the same value.



6.2.4 Signal Invert, Delay and Output Level (Page 3)

Each output can be phase inverted by 180° (separate to the phase-alignment for cross-over), delayed for system alignment and the level attenuated or boosted.

Delay can be specified in terms of time or distance, as preferred. The unit of measurement is changed in the Set Up menu (see Section 7.6).

The Level entered here sets the baseline output level, i.e. the 'zero' value, for the rotary Output Gain controls. For example, if the Level is set to 6dB, the 0 represents 6dB. Turning the rotary Gain Control right/left will increase/decrease the level in a proportional manner beyond 6dB (it is not directly additive since the gain is limited to +12dB). Hence, the Output Gain controls enable fine-tuning during a performance while the baseline output level is retained as a standard setting for future use.

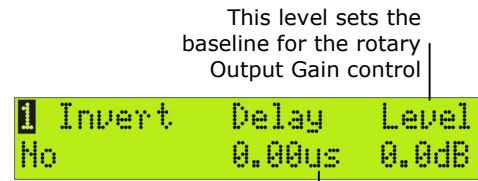

This level sets the baseline for the rotary Output Gain control

Delays can be set in seconds, metres, or feet.

▶▶ To invert the output signal

- Turn the left-hand knob clockwise until the Invert field reads 'Yes'. The default setting is 'No' inversion.

▶▶ To set the delay

- Turn the centre knob slowly for step increments, or sharply to leap to the bottom/top of the range (1-2 sharp turns covers the whole range). The range is 0 to 1ms in steps of 20.83µs and 1ms to 300ms in steps of 0.01ms, or the equivalent in metres or feet.

▶▶ To set the base level for the front panel Gain control

- Turn the right-hand knob. The range is -40dB to +12dB in steps of 0.1dB, with an OFF position just 'below' -40dB. Setting the gain to OFF will mute the input signal.

6.2.5 Phase Adjustment (Pages 4 and 5)

To meet the demands of a wide range of situations, the Klark Teknik DN9848 provides two all-pass filters with complementary control parameters for fine-tuning the phase response on each output, e.g. for alignment at cross-over. The first filter is presented as a "phase shifter" for which you can set a *specific phase shift at a reference frequency*, eg. the HPF or LPF (typically the cross-over point). The second filter enables a *1st or 2nd order phase shift to be applied at a chosen frequency*. With 2nd order, the phase shift window can be shaped, i.e. you can adjust the steepness of the transition by setting the Q value.

For detailed information on how these filters modify the signal, please refer to the Application Notes section.

▶▶ To set a precise phase shift at a reference frequency

- 1 Step to the Phase Angle/Ref page shown right.
- 2 Turn the centre knob to select a phase angle between 0° and 180°. Turn the right-hand knob to set the reference frequency to HPF, LPF or one of the six PEQs (set in the subsequent Output menu pages).





▶▶ To apply a 1st order phase adjustment in relation to a chosen frequency

- 1 Step to the All-Pass page shown right.
- 2 Turn the right-hand knob to enable a 1st (90°) order shift.
- 3 Turn the left-hand knob to the required frequency.

```

All-Pass Freq,Q,Enable
4.68kHz    ---    1st
  
```

▶▶ To apply a 'shaped' phase transition at a chosen frequency

- 1 Step to the All-Pass page.
- 2 Turn the right-hand knob to enable a 2nd (180°) order shift.
- 3 Turn the centre knob to select the Q (slope) and the left-hand knob to select the frequency.

```

All-Pass Freq,Q,Enable
6.52kHz    1.4    2nd
  
```

6.2.6 High Pass and Low Pass Filters (Pages 6 and 7)

The DN9848 provides the following high and low pass filter (HPF and LPF) options for cross-over purposes:

Butterworth	6, 12, 18, 24, 36 and 48dB / Octave
Bessel	12, 18, 24, 36 and 48dB / Octave
Linkwitz Riley	12 and 24dB / Octave
Peaking (HPF only)	12 and 24dB / Octave 0-6dB Gain
Bypass	No Filter

▶▶ To add a high/low pass filter to output processing

- 1 Step to the HPF or LPF page, as required (see right).
- 2 Use the left-hand knob to specify the cut-off frequency.
- 3 Use the centre knob to select the filter type and the right-hand knob to set the slope/gain. (The right-hand parameter switches between slope and gain, dependent on the filter type).

```

HPF    Freq,Type,Slope
20.0Hz Bypass    ---
  
```

```

LPF    Freq,Type,Slope
20.0kHz Bypass    ---
  
```

▶▶ To bypass the high/low pass filter processing

- 1 Step to the HPF or LPF page, as required.
- 2 Turn the centre knob anti-clockwise to 'Bypass'. The last selected values for each type of filter are retained in the background for easy recall.



6.2.7 Parametric Equalisation (Pages 2 to 13)

The DN9848 provides six parametric equalisation stages on each output channel, for equalising the output signal in respect of loudspeaker and/or system characteristics. The first and last of these PEQ sections can be alternatively be configured for lower and upper shelving equalisation. All the PEQ sections can be used across the full range from 20Hz to 20kHz and are set independently via their own menu page.

Any PEQ can be used as the reference frequency for the Phase Shifter (see Section 6.2.5)



►► To set a PEQ

- 1 Set a centre frequency (21 steps per octave) and bandwidth (0.08 to 3 Oct) for the PEQ section, using the left and centre knobs, respectively.

or

Switch to an LEQ/HEQ setting with a 6dB or 12db slope by turning the centre knob clockwise beyond 3 Oct (see below). Use the left-hand knob to set the LEQ/HEQ frequency.

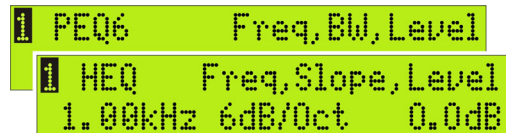

- 2 Turn the right-hand knob to set an attention/boost level between -12dB and +12dB.

If a PEQ section is not needed in the set up, set its level to 0dB.

6.2.8 Compression (Page 14)

Each output has an independent full range compressor to improve the audio dynamics and/or reduce louder signal levels to avoid loudspeaker damage. The compressors are variable ratio and can be set to a hard knee characteristic for a sharp gain reduction response at the compression threshold, or soft knee for a more 'musical' response.

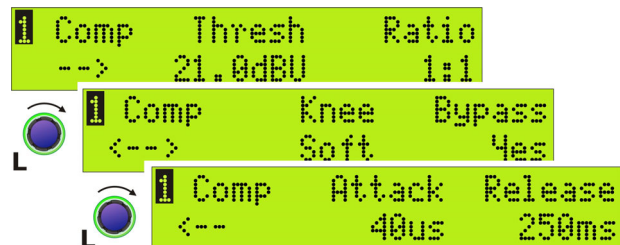

►► To set the compressor parameters

- 1 On the first compressor menu page, use the centre knob to select a threshold value in the range -10dB to +21dB, and the right-hand knob to set a ratio from 1:1 to 5:1.
- 2 Turn the left-hand knob clockwise to access the first sub-menu page. Use the centre knob to select a hard or soft knee characteristic and the right-hand knob to set the bypass state to No so that the compressor is included in the signal path. The relative position of the compressor threshold to the limiter threshold will be indicated by a lit segment at the meter (provided the compressor threshold is below the limiter threshold).

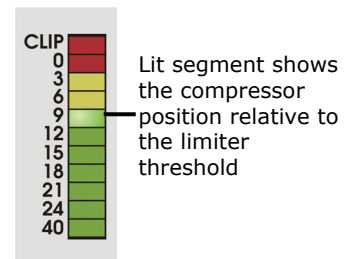



- 3 Turn the left-hand knob clockwise to access the second sub-menu page. Use the centre knob to set the compressor attack time (range of 40ms – 1ms in 20ms steps or 1ms to 100ms in 1ms steps). Use the right-hand knob to set the release time (10ms to 2s in 10ms steps).

►► To switch the compressor out of the circuit

- Set the bypass state on the second page to 'Yes'. The other settings will be retained for future use.

6.2.9 Output Limiter

In addition to compression, each DN9848 output has a limiter to protect any attached equipment being driven into clip and potentially being damaged. Notably, the DN9848 uses a special 'look-ahead' limiter so that it can anticipate transient overshoots and act 'immediately' (see Application Notes for further details). The limiter threshold can be adjusted to accommodate the varying requirements of commercial equipment.

Limit	Thresh, Rel, Knee
21.0dBu	50ms Hard

►► To set the limiter parameters

- 1 Select a threshold value in the range -10dB to +21dB with the left-hand knob.
- 2 Use the centre knob to set a release time between 1ms and 100ms.
- 3 Use the right-hand knob to select a hard or soft knee characteristic for a sharp or gradual cut-off, respectively.

►► To switch the limiter out of the circuit

- Turn the left-hand knob fully clockwise until the threshold value reads 'OFF' (a sharp turn will leap to the OFF position).

6.3. Monitoring the Output Signal

Each of the eight outputs has an 11-segment signal meter for monitoring internal signal clipping and output levels that may cause damage to the loudspeaker equipment.

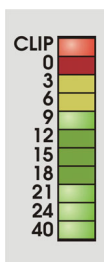

The top CLIP segment monitors the internal signal clipping. It operates independently of the rest of the meter, lighting if signal clipping is detected at any stage in the processing circuits regardless of whether the level of the final processed signal is above or below the compressor and/or limiter thresholds. Hence, the audio engineer has full visibility of any internal signal clipping that may result in audio distortion.

The 0 to - 40 signal meter is primarily designed to monitor the output level with respect to excessive levels that may cause damage to the onward loudspeaker equipment. To do this it uses a dual-purpose scale that refers the signal level to both limiter threshold and compressor threshold, as illustrated and described overleaf.

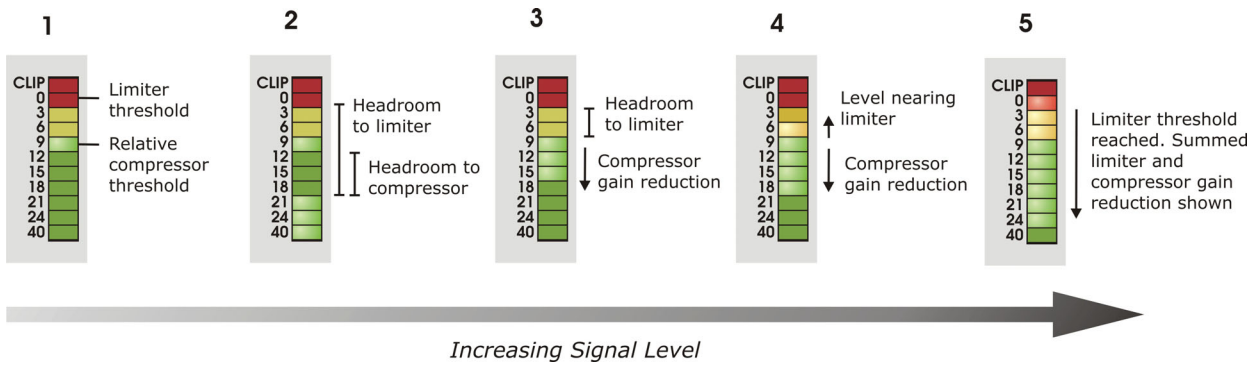

1 The meter uses a downward relative scale where the 0 segment represents the limiter threshold. For example, if the limiter threshold is set to +5dB in the output menu page, then the signal meter 0 segment represents 5dBu true value, the -3 segment becomes 2dBu down, -6 becomes -1dBu down and so on.

The compressor threshold is also marked, relative to the limiter threshold, by a single steadily lit segment. For example, when the limiter threshold is set to 8dBu, the 0 segment is 8dBu; if the compressor threshold is -1dBu, segment 9 will be lit.

Note If the limiter is set to OFF, the meter is scaled relative to 21dBu.

2 While the signal level lies below the compressor threshold, the meter lights upwards from -40 such that the current headroom to both the compressor and limiter thresholds can be monitored.

3 When the signal level reaches the compressor threshold level, the meter 'flips' and reads downwards to show the amount of gain reduction applied to the signal.

4 With further increase, the meter reads in both directions: i.e., it increments upwards to track the signal level as it approaches the limiter threshold and increments downwards to show the applied gain reduction.

5 When the limiter kicks in, the meter flips to read downwards from the 0 segment instead of just from the compressor threshold. It now shows the summed gain reduction from both compressor and limiter.

6.4. Output Gain and Mute - Front Panel Control

Each output is equipped with a dual action rotary/push-switch control for adjusting or muting the output level. Note that zero mark on the control refers to the baseline output level set in the Output menu (see Section 6.2.4) and hence the rotary control provides fine-tuning referred to this level.

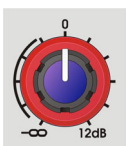

- | | |
|--------------------------------|--|
| To increase/decrease the level | turn clockwise/anti-clockwise |
| To mute an output | push in and hold until the red ring lights |
| To un-mute an output | push in and hold until the red ring light goes out. |
| To mute all outputs | push in and hold an unlit output until it and then all other controls light |
| To un-mute all outputs | push in and hold a muted (lit) output until it and then all other red rings go out |



7. DN9848 SET UP OPTIONS

7.1. General

The DN9848 provides various set up options for adapting the operation of the unit to best suit your operational requirements and preferences, as follows:

- ▣ Comms channel setting for remote control
- ▣ Security features
- ▣ Display lighting
- ▣ Unit and memory naming
- ▣ Delay units of measurement
- ▣ Power up settings

These options are programmed in the Set Up menu and are described below in menu order.

►► To access the Set Up menu pages

- Press HOME (SET UP) to return to the Home page.
- Press and hold the HOME (SET UP) button to open the menu.
- Press the HOME (SET UP) button repeatedly to step through the pages in turn.

Note that this menu does not 'cycle'. On completing the set up, the menu returns to the Home page.

7.2. Remote Comms Channel (Page 1)

This page specifies the communications channel on which the unit will send and receive data to/from a controlling PC. Channels 1 to 32 are available, enabling a slave network of up to 32 DN9848 Equalisers to be controlled from a PC using Stardraw or Smaart software. DN9848 remote control set ups are covered in Section 9.

```
Comms      channel,---,---
Off
```

7.3. Security Settings (Pages 2 and 3)

7.3.1 Front Panel Lock (Page 2)

This option is used to set a password and lock out the all, or nearly all, of the front panel controls to protect settings from tampering by unauthorised personnel. Five levels of Panel Lock are possible:

- ▣ **Unlocked** – All controls available.
- ▣ **Lock + Recall** – This leaves the Recall button active so that saved memories can be still be recalled.
- ▣ **Lock + Recall + Mute** - As above but also leaves the Mute controls active.
- ▣ **Lock + Mutes** – Leaves the Mute controls only active.
- ▣ **Locked** – Imposes a full lockout on the front panel controls.

```
PanelLock <>,chr, type>
Unlocked  MOCK PASSWRD
R PanelLock --,---,<type>
Lock+Recall Home accepts
R PanelLock --,---,<type>
Lck+Rcl+Mte Home accepts
R PanelLock --,---,<type>
Lock+Mutes Home accepts
R PanelLock --,---,<type>
Locked   Home accepts
```

In all cases, limited Set Up menu options remain available, namely the Comms Channel, Panel Unlock pages and Power Up pages.



▶▶ To set a Panel Lock

- 1 Step through the Set Up menu to the Panel Lock menu page.
- 2 Use the left and centre knobs to set a password of 12 characters, including blank spaces, made up of letters, numbers and/or symbols.

Important! Note that preliminary and subsequent blank spaces are recorded as part of the 12-character password; therefore if you use a short password, the characters must be re-entered in exactly the same position to unlock the panel. To avoid confusion, either record the blanks as part of the password or enter the word at the far left of the display.

- 3 Turn the right-hand knob clockwise to cycle to the required lock type.
- 4 Press **HOME** to apply the Panel Lock.

The Home page now indicates that the unit is 'Locked'. The lock state is retained after power down, and will be indicated on the Home page when the unit is powered up again.

▶▶ To remove the Panel Lock

- 1 Step through the Set Up menu to the Panel Lock page.
- 2 Use the left and centre knobs to enter the password. Note that the letters must be in the same position as when the password was set.
- 3 Turn the right-hand knob clockwise to apply the password.
- 4 If correct, the display will report 'UNLOCKED'. Press **HOME** to exit the page and return to normal operation.

If you have entered the wrong password, the DN9848 will flag it as incorrect and return to the Panel Unlock page for a further attempt.

7.3.2 System Protect (Page 3)

System Protect offers limited operational control while protecting against unauthorised users tampering with key parameters that may result in loudspeaker damage.

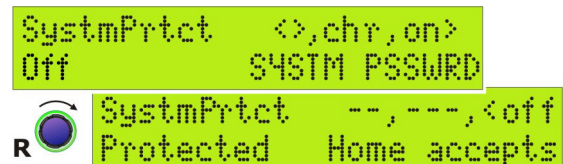

▶▶ When System Protect is on

- ▣ The output **MENU ACCESS** buttons and Output Mute controls are disabled, but the inputs can still be edited.
- ▣ User memory settings can be recalled or stored, but factory and system memories are inaccessible.
- ▣ The full Set Up menu is still available.

Note Panel Lockout takes priority over the System Protect state.



▶▶ To switch System Protect on

- 1 Step through the Set Up menu to the System Protect menu page.
- 2 Use the left and centre knobs to set a password of 12 characters (including blank spaces) made up of letters, numbers and a limited number of symbols.

Important! Note that preliminary and subsequent blank spaces are recorded as part of the 12-character password; therefore if you use a short password, the characters must be re-entered in exactly the same position to unlock the panel. To avoid confusion, either record the blanks as part of the password or enter the word at the far left of the display.

- 3 Turn the right-hand knob ('on>') clockwise to accept the password and switch protection on.
- 4 Press **HOME** to apply the System Protect state.

The Home page now indicates the unit is locked with inputs editable. The System Protect state is retained after power down, as will be shown on the Home page when the unit is powered up again.

▶▶ To switch System Protect off

- 1 Step through the Set Up menu to the System Protect page.
- 2 Use the left and centre knobs to enter the password. Note that the letters must be in the same position as when the password was set.
- 3 Turn the right-hand knob clockwise to apply the password.
- 4 If you have entered the wrong password, the DN9848 will flag it as incorrect and return to the Panel Unlock page for a further attempt.

If accepted, the password cursor stops flashing. When you next access this menu page, System Protect will be in the default Off state.

7.4. LCD Lighting (Page 4)

If required, the lighting of the alphanumeric display can be adjusted to accommodate off-axis viewing.

```
LCD contrast,---,---  
5
```

▶▶ To adjust the lighting

- Step to the LCD page, and turn the left knob to adjust the display contrast. The default setting is 5, with a range of 0-10.

7.5. Naming (Pages 5 and 6)

To help with system identification, the DN9848 unit and the current working memory may each be given a name up to 24 characters long.

Both names are shown in the Home page and are retained after power down, which is particularly useful for system reassembly when changing venues.

```
Name of unit <>,chr,---  
Klark Teknik DN9848
```

```
NameWorkingMmry <>,chr,-  
DEFAULT
```

▶▶ To enter a name

- Use the left-hand knob to move the cursor right or left, and the centre knob to select the letter, number or symbol. The name is automatically applied.



Names can also be allocated to individual input and output channels via their associated menus (see Sections 5.2.2 and 6.2.2).

All names are stored with User and System memory settings. The Store function will assume the working memory name as the default memory name, prompting you to edit it if required (see Section 8 Storing and Recalling Settings).

7.6. Delay Options (Page 7)

The units of measurement used to specify the delay on the input and output channels can be set to suit user preference, as follows:

- ▣ Time (milliseconds and microseconds)
- ▣ Metric distance (metres)
- ▣ Imperial distance (feet and inches)

```
Delay      units,temp,---  
Metric     20°C
```

▶▶ To change the units of measurement

- 1 Turn the left-hand knob to choose the units.
- 2 For Metric or Imperial distance measurement, specify the ambient temperature of the venue using the centre knob. The DN9848 will use this to adjust the speed of sound (which varies with temperature) in the delay calculation so that accurate delays are applied to the channels.

The delay units are changed in the input and output menus, with the current values being automatically converted to equivalent values.

7.7. Power Up Options (Page 8)

Two power up options are provided as follows:

- ▣ Logo On/Off- This refers to the logo animation displayed at start up.
- ▣ Output Level Ramp – This is used to apply a gradual ramp up to full output levels when you power on the unit, e.g. to avoid sudden power surges in larger systems. The ramp can be adjusted between 0 – 32s and will recover the output mute states held when the unit was last switched off. Alternatively, an initial mute can be automatically applied to all of the outputs (on a ramp setting; this is the default setting).

```
Pwr_Up logo,level ramp,-  
Logo On   Ramp  0 sec
```

▶▶ To switch the logo on/off, turn the left-hand knob.

▶▶ To change the ramp up time at the outputs, turn the centre knob. The 'Outputs Muted' option is found just below 0s.



8. STORING AND RECALLING SETTINGS

The DN9848 Loudspeaker Processor is provided with the following memory facilities:

- ▣ 32 lockable System memories, designated as S01 to S32, for storing standard set ups in battery-backed-up SRAM.
- ▣ 5 free access User memories, designated as U01 to U05, for storing a series of set ups for the current show.
- ▣ 99 Preset (flash) memory locations, designated P01 –P99, for secure storage of essential settings against overwriting or battery failure. These memories can only be programmed from an external computer. Up to 25 Factory Presets, including cross-over set ups for commonly used EV and third-party loudspeaker systems, are available at www.klarktechnik.com for downloading to the unit via the front panel PC port. These are listed with the Technical Specification in Section 11.

▶▶ To store settings

- 1 Press the black **STORE** button to access the Store menu.
- 2 To include the current trims in the memory, i.e. the settings on the front panel Output Level controls, turn the right-hand knob to select 'Yes'.
- 3 Press **STORE** to move to the next menu page. Select a User (U01 –U05) or System (S01 – S32) memory location using the left-hand or centre knob, respectively.



```
STORE Mmry ---,---, 4/N
Store output trims? No
```

```
STORE ??? user,sys,---
```

```
STORE U01 user,sys,---
STORE=accept HOME=abort
```

Note Since a memory location is now active, you should only press **STORE** if you wish to accept and continue the storing process. Otherwise, press **HOME** to abort.

- 4 Press **STORE** to accept the memory location and move on.
- 5 The current working memory name is displayed (as defined in the Set Up menu). To change the name before storing, use the centre knob to move the cursor right or left, and the right-hand knob to select the letter, number or symbol.
- 6 Press **STORE** to confirm the action and return to the DN9848 Home page.

```
STORE U01 <>,chr,---
FIRST SET
```

The DN9848 automatically checks the memory settings and displays a warning if any errors are found. Where possible, it will also attempt to automatically correct the error.

▶▶ To lock the system memories, refer to Section 7.3 Security Settings.



►► To recall stored settings from memory

- 1** Press the black **RECALL** button to access the Recall menu.
- 2** Select a User, System or Preset memory using the left, centre or right-hand knob.
- 3** Press **RECALL** to confirm the action and return to the DN9848 Home page.



```
RECALL U01 user, sys, pre  
RECALL=accept HOME=abort
```

The selected memory settings are recalled to the working memory.



9. DN9848 REMOTE CONTROL SETUP

Up to 32 DN9848 Loudspeaker processors can be linked together in a daisy-chain RS-485 network for remote control from a computer running the commercially available Stardraw or Smart software. Further details of these applications are available from the Klark Teknik website at www.klarktechnik.com.

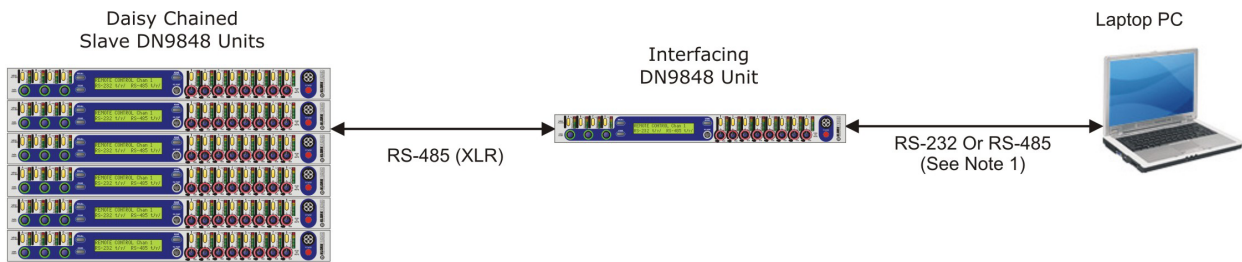

Note:
RS-232 connection is via front panel PC Port and supports a system of up to 32 units .
RS-485 connection is via the COMMS IN XLR socket on rear panel and supports a system of up to 31 units.

This section specifically covers how to connect and configure the DN9848 units for remote operation. For operational guidance on using the Stardraw or Smart remote control applications with the DN9848, please refer to the manufacturer’s documentation.

►► To set up a slave network of DN9848 units for remote control from a PC,

- 1 Using standard balanced mic cables, connect the DN9848 units together in a daisy chain sequence from the rear panel RS-485 COMMS In connector on one unit to the COMMS Out on the next. The first unit in the chain will have no connection to its input, and the last unit will have no connection to its output. Note that when using an RS-232 connection to the PC, up to 32 units can be included in the daisy chain, but when using an RS-485 connection to the PC, the maximum is 31 units.
- 2 Power up and put each unit in remote control mode by assigning it a unique Comms channel address as follows:
 - ▣ Press and hold the **HOME (SETUP)** button to access the Comms menu page.
 - ▣ Use the left-hand knob to select a channel between 1 and 32.
 - ▣ Press **HOME (SETUP)** to accept.



The front panel controls, except the **HOME (SETUP)** button, are locked out to facilitate remote operation. The display indicates that the unit is under remote control.

Note | The order of the addresses does not need to mirror the order of the daisy chain networking, but each unit **MUST** have a unique comms channel address.

- 3 Referring to the table overleaf, connect your laptop/PC to the DN9848 daisy chain as relevant to your specific system set up. Note that, as the RS-485 network has through connections, you may connect the PC to any unit in the chain.



DN9848 Connection	Laptop/PC Connection	Cable /Converter Required
RS-232 input to front panel PC PORT for short cable run	D9 COM port	Host cable
	USB port	KK systems USB/232 converter plus host cable
RS-485 input to rear panel COMMS In XLR connector for long cable run	D9 COM port	RS-232/485 converter, e.g. KT LBB-485 powered from PS2 mouse port
	USB port	Or KK systems K3-ADE plus power supply* B+B Electronics USOTL4

*For full details of recommended converters and pin out connections please refer to the KlarkTeknik.com website at http://www.klarktechnik.com/faq_connections.htm .

- 4 Boot up (or re-boot) your laptop/PC.

Important!

If the connection is made to an already running laptop/PC, you must re-boot to ensure the new COM or USB port is reliably recognised. This is a limitation of the port devices.

- 5 Open your Stardraw or Smaart application.

Your network is now ready for remote control operation. Successful communications is indicated by 'rotating' t/r symbols.

►► **To disable remote control**

- 1 Press and hold the **HOME (SETUP)** button to access the Comms menu page.
- 2 Use the left-hand knob to set the Channel to Off.
- 3 Press the **HOME (SETUP)** button to accept.

The unit front panel controls are now available for manual operation.



10. APPLICATION NOTES

10.1. The Advantage of DN9848 Look-Ahead Limiters

The limiter in a loudspeaker processor is the last line of defence in protecting the speaker drivers from damage, and as such it has a very specific and critical job to do. One of the chief modes of loudspeaker failure is driver over-excursion, and unless the limiter is designed to act instantly in response to sudden increases in level, it will allow through brief transients that can cause damage through over-excursion. All dynamics processors take a finite amount of time to respond to a change in input level, and unless additional steps are taken the result is that the input signal is initially let through at anything up to its full level, until the gain element in the limiter can act in response to the increase in signal level.

The DN9848 exploits the fact that digital signal processing works on a sample-by-sample basis (the signal data samples are clocked through the unit at the sample rate of 48 kHz) and that there is a small delay through each processing block, and literally 'looks-ahead' further back in the signal chain to sample the data for the limiter side chain, so that the limiter can apply the required gain reduction on an instantaneous sample-by-sample basis, so that the limiter never lets through any dangerous transients.

In the example below a 10 kHz tone burst of 10 ms duration has been used as the input signal and the output of both a DN9848 and a leading competitor are shown. Note the very large transient of the competitor unit which does not have a look-ahead limiter.

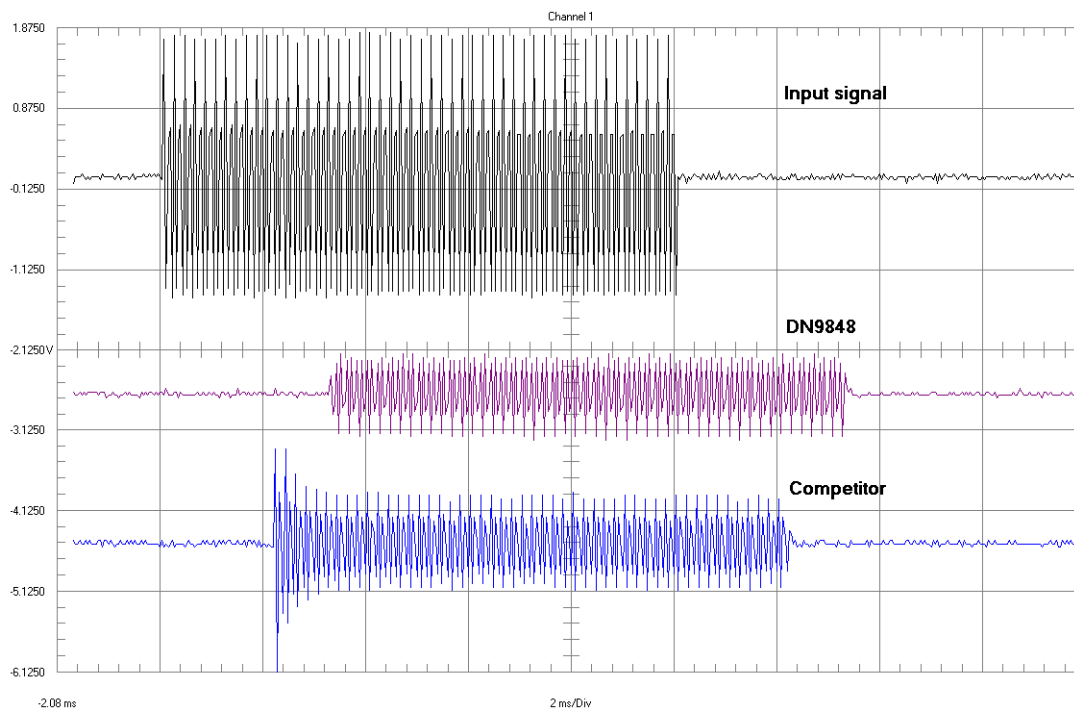

Signal source: Audio Precision System One

Settings: Waveform: Burst – Normal. Frequency: 10.0 kHz. Burst: 10 ms. Interval: 100 ms. High Level: +10.0 dBu Low level: -40.0 dBu

DN9848 settings: HPF: 1.25kHz Lnk-Ril 24dB/Oct. LPF: 20kHz Lnk-Ril 24dB/Oct. Limiter Threshold: 0.0dBu Release: 50ms Response: Hard Knee

Competitor settings: HPF: 1.26kHz Lnk-Ril 24dB/Oct. LPF: 22kHz Lnk-Ril 24dB/Oct. Limiter Threshold: 0.0dBu Attack & Release: Automatic

All other settings are default on both units.

As with all units that use sigma-delta ADC and DAC converters, there is a propagation delay from input to output, 3.2 ms for the DN9848 and 2.1 ms for the competitor unit, the additional delay in



DN9848 is caused by the use of sigma-delta converters for both analogue-to-digital and digital-to-analogue conversion (the competitor unit uses a different method of digital-to-analogue conversion), which allows the DN9848 to achieve its superior dynamic range.

In order to prevent driver failure, the competitor product's limiter threshold needs to be reduced such that the peak of the transient is at the same level as the threshold of the DN9848's look-ahead limiter, with a major effect on efficiency of speaker systems, as the effect of reducing the limiter threshold is to limit the amount of continuous output power available, which means more amplifiers and more speaker cabinets to achieve the same SPL. In the example below the competing unit's limiter threshold has been reduced so that level of the transient peak matches the threshold of the DN9848's limiter:-

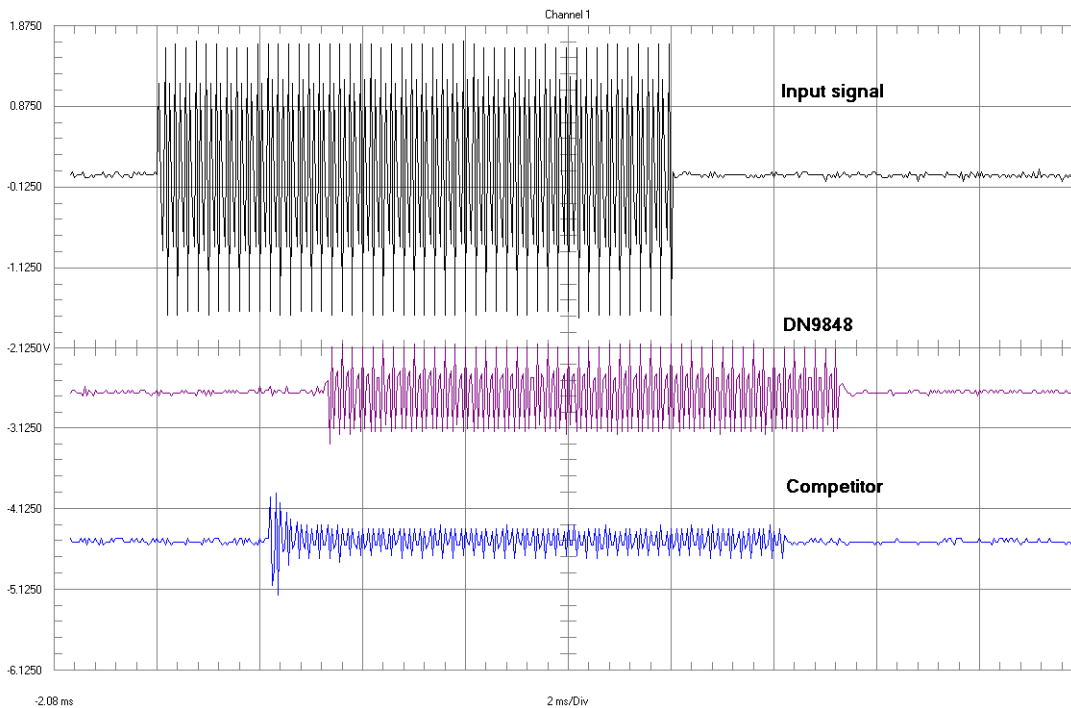

The limiter threshold of the competitor's unit has been lowered to -10.0 dBu to avoid the risk of driver damage from the initial transient, at the cost of greatly reducing the efficiency of the PA system. The look-ahead capability of the DN9848's limiters allows the thresholds to be set at the levels required to protect the loudspeaker drivers, without the need to be concerned about transients being passed by the limiters. This allows the PA system performance to be maximised by safely exploiting the full operational range of the loudspeaker drivers.



10.2. Phase-adjustment with the DN9848

To meet the demands of a wide range of situations, the Klark Teknik DN9848 provides two all-pass filters with complementary control parameters for fine-tuning the phase response on each output. Although some cross-over filter designs, e.g. Linkwitz-Riley types, are inherently phase-aligned at cross-over, others such as Butterworth or Bessel responses may require manual phase alignment. Even Linkwitz-Riley filters may not produce accurate phase coherence when HPF and LPF are combined to produce a band-pass output. In addition, the phase response of the drive units and cabinets (especially horn-loaded types) may require compensation to achieve correct *acoustic* phase, even if the electrical phase is correct. The DN9848 filters provide straightforward tuning control in all cases.

The first filter of the DN9848 is presented as a “phase shifter” for which you can specify a particular *phase shift* at a *reference frequency*, namely a HPF or LPF (typically the cross-over point) or one of the 6 PEQs. The plots in the graph below show the effect of these controls on the filter response when set to a 90° phase shift at reference points equivalent to 20Hz, 300Hz, 1kHz and 20kHz. Referring to the figure, the overall response always remains the same shape i.e. tending from +180° at low frequencies to 0° at high frequencies, but is shifted along the frequency axis to achieve the required phase shift at the specified reference point.

Audio Precision

90 deg phase shift @ 20, 300, 1K, 20K

01/19/01 15:52:45

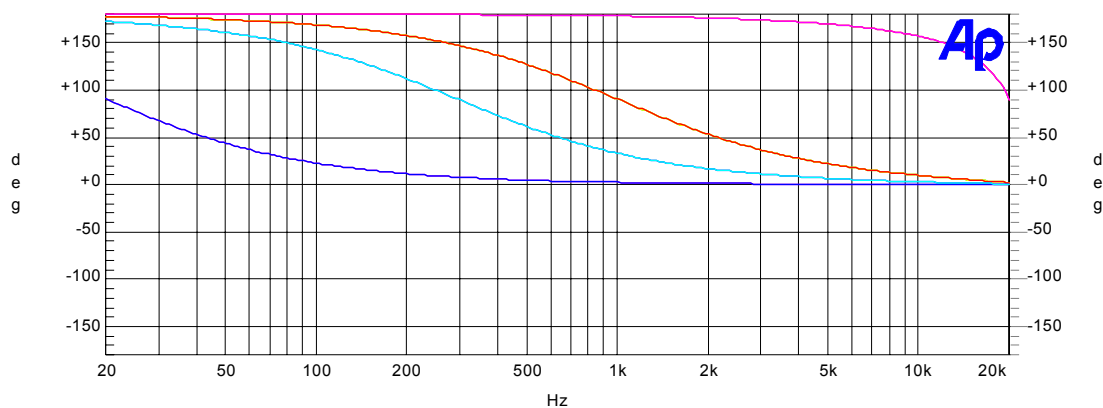

Color	Line Style	Thick	Data	Axis
Green	Solid	1	Anlr.Phase	Left
Yellow	Solid	1	Anlr.Phase	Right
Yellow	Solid	1	Anlr.Phase	Left

phase.at1

Response of the phase shifter filter for a phase shift of 90° at reference points equivalent to 20Hz, 300Hz, 1kHz and 20kHz

The second filter, presented to the user as an “all-pass filter”, enables the user to set the *Order* and *Q* of the phase shift, at a particular *Frequency*. The Order can be switched to Off (no filter), 1st order (90° shift) or 2nd Order (180° shift).

The graph over the page shows the response of the filter for a 1st order shift. In this mode, the *Q* control is disabled. As can be seen, the filter behaves in an identical manner to the phase shifter, i.e. the response tends from +180° at low frequencies to 0° at high frequencies, shifted along the frequency axis according to the chosen frequency. In effect, this is a phase shifter for which the frequency is entered directly, rather than being referred to a HPF/LPF or PEQ section.



Audio Precision

1st order allpass @ 300, 1K, 10K

01/19/01 16:00:02

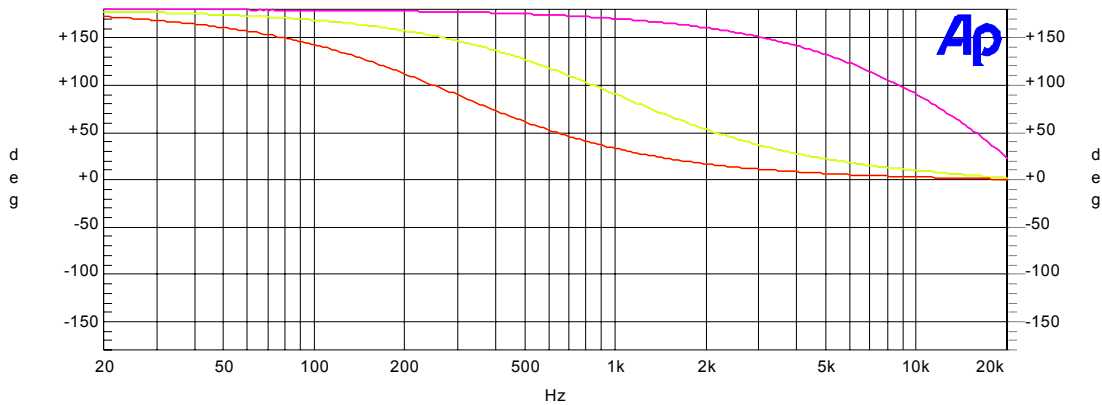

Color	Line Style	Thick	Data	Axis
Green	Solid	1	Anlr.Phase	Left
Yellow	Solid	1	Anlr.Phase	Right
Yellow	Solid	1	Anlr.Phase	Left

phase.at1

Response of the All Pass Filter for 1st Order phase shift at frequencies of 300Hz, 1kHz and 10kHz

The response of the filter for a 2nd order shift is shown below with the Q control set to 1, at frequencies of 300Hz, 1kHz, and 10kHz, and also Q set to 6 (max) and 0.4 (min) at 1kHz. As can be seen, the filter response now tends from 360° at low frequencies to 0° at high frequencies, and Q controls the rate at which the phase changes (i.e. the slope) around the transition point. With low Q, the phase changes gradually across the whole frequency range. With high Q, the phase changes rapidly in the transition area, and is unchanging at 360°/0° over the remainder of the frequency spectrum. Hence, the 2nd order all-pass provides the user with the additional control of shaping the phase shift 'window'.

Audio Precision

2nd order allpass Q=1 @ 300, 1K, 10K + Q=6 Q=0.4 @ 1K

01/19/01 16:09:11

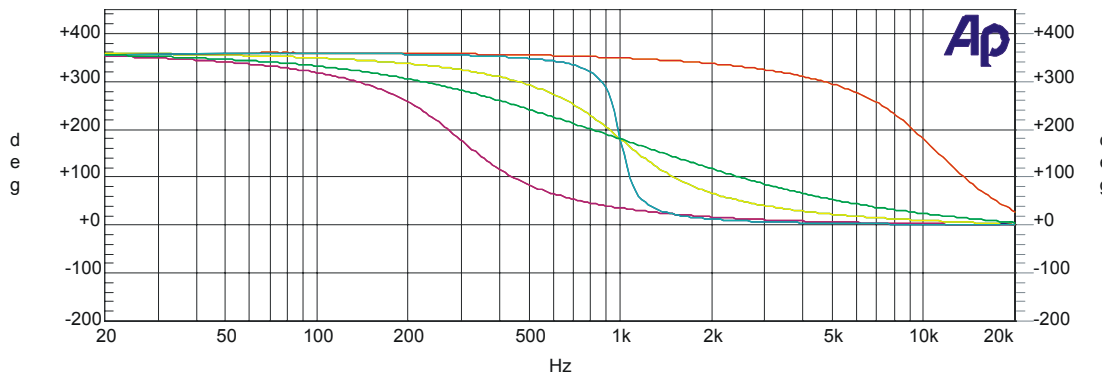

Color	Line Style	Thick	Data	Axis
Green	Solid	1	Anlr.Phase	Left
Yellow	Solid	1	Anlr.Phase	Right
Yellow	Solid	1	Anlr.Phase	Left

phase.at1

Response of the all pass filter for 2nd order phase shift with Q=1 at frequencies of 300Hz, 1kHz and 10kHz and also with Q=6 at (max) and Q=0.4 (min) at 1kHz

Note: Both filters are all-pass with a flat amplitude response between 20Hz and 20kHz; only the phase response changes with frequency.



11. TECHNICAL SPECIFICATION

Audio Inputs (four)

Type	Electronically balanced (Pin 2 Hot)
Impedance (Ω)	Balanced 20k, Unbalanced 10k
Common Mode Rejection	>80dB @ 1kHz
Maximum level	+ 21dBu

Audio Outputs (eight)

Type	Electronically Balanced (Pin 2 Hot)
Minimum load impedance	56 Ω /20nF
Source impedance	56 Ω
Maximum level	+ 21dBu into > 2k Ω

Performance (20Hz to 20kHz)

Frequency response	+/- 0.3dB with all filters and EQ flat
Distortion @ +8dBu	<0.02%
Dynamic range (unweighted)	>113dB

Input Processing (per channel)

Gain	+12dB to -40dB in 0.1dB steps plus Off
Delay	0 to 1 second in 20.83 us steps (0 - 343.53 m or 0 - 1127' 0" at 20 μ C)
Parametric EQ 1-12	Frequency range: 20Hz to 20kHz in 21 steps per octave
Boost/cut:	+6/-18dB in 0.1dB steps
Bandwidth:	3.0 to 0.08
Compressor	
Threshold:	+21dBu to -10dBu in 0.1dB steps
Attack:	40 μ s to 100ms in 20 μ s steps and 100ms -1s in 1ms steps
Release:	10ms to 2000ms in 10ms increments
Ratio:	1:1 to 5:1 in unit increments
Knee:	Hard/Soft
Bypass:	Yes/No

Output Processing (per channel)

Routing from Inputs	None From Channels A, B, C or D From Channels A+B or C+D, with ratio control, attenuated by 6dB before summing From Channels A+B+C+D, attenuated by 12dB before summing Note: Sources comprising summed channels are only available if the input channel delays for the summed channels are set to the same value.
Phase invert	Normal/invert
Output gain	+12dB to -40dB in 0.1dB steps plus Off
Delay	0 to 300 milliseconds (0 - 103.06 m or 0 - 338' 1" at 20 μ C)
Output phase correction filter	
Phase angle:	0° to 180° in 5° steps. 0° is off
Angle Reference:	LPF, HPF, LEQ/PEQ1, PEQ2, 3, 4, 5, or HEQ/PEQ6
Output all-pass filter	
Freq. Range:	20Hz - 20kHz in 21 steps per octave
Phase shift	1 st (90°) or 2 nd (180°) order
Q (2 nd order only)	0.4 to 6.0



High pass filter

Types available	Butterworth (6dB/Oct, 12dB/Oct, 18dB/Oct, 24dB/Oct, 36dB/Oct, 48dB/Oct) Linkwitz-Riley (12dB/Oct, 24dB/Oct) Bessel (12dB/Oct, 18dB/Oct, 24dB/Oct, 36dB/Oct, 48dB/Oct) 12dB/Oct Peaking 24dB/Oct Peaking
Freq. Range:	20Hz to 15kHz in 21 steps/octave
Peaking Filter Boost:	0dB to +6dB in 0.1dB steps.

Low pass filter

Types available	Butterworth (6dB/Oct, 12dB/Oct, 18dB/Oct, 24dB/Oct, 36dB/Oct, 48dB/Oct) Linkwitz-Riley (12dB/Oct, 24dB/Oct) Bessel (12dB/Oct, 18dB/Oct, 24dB/Oct, 36dB/Oct, 48dB/Oct)
Freq. Range:	50Hz to 20kHz in 21 steps/octave

Parametric EQ 1 –6

Frequency range:	20Hz to 20kHz in 21 steps per octave
Boost/cut:	+12/-12dB in 0.1dB steps
PEQ Bandwidth:	3.0 to 0.08

Low/High shelf filter

Frequency range:	20Hz to 20kHz in 21 steps per octave
Boost/cut:	+12/-12dB in 0.1dB steps
Shelf slope:	6dB/Oct and 12dB/Oct

Compressor

Threshold:	+21dBu to -10dBu in 0.1dB steps
Bypass:	Yes/No
Attack:	40ms to 100ms in 20us increments up to 1ms, then in 1ms increments.
Release:	10ms to 2000ms in 10ms increments
Ratio:	1:1 to 5:1 in unit increments
Knee:	Hard/Soft

Look-ahead limiter

Threshold:	+21dBu to 10dBu in 0.5dB steps
Release:	10ms to 1000ms
Knee:	Hard/Soft

Mute

On/off (Press output trim)

Power Requirements

Voltage	90 to 250V AC @ 50/60Hz
Consumption	< 60 VA
Fuse rating	T 800mA, L 250 V

Dimensions & Weight

Width	483mm (19 inch)
Height	44mm (1.75 inch)
Depth	287mm (12 inch)
Nett	4kg
Shipping	6kg

Terminations

Audio inputs/outputs	3-pin XLR
RS-485 inputs/outputs	3-pin XLR
RS-232	8-pin Mini-DIN socket
Power	3-pin IEC



Factory Presets for X-Array Series

Memory Identification	In	Out							
		1	2	3	4	5	6	7	8
P01 XW15 – 4MIX R1-3 4 x EV XW15 15" Bi-amped (8 outputs used)	A	LF	HF						
	B			LF	HF				
	C					LF	HF		
	D							LF	HF
P02 XN/XB/2XF R2- 1 x EV XN + EV XB + 2 x EV XF (8 outputs used)	A	Xn LF	Xn MB	Xn HF	Xb LF	Xf MB	Xf HF	Xf MF	Xf HF
	B								
	C								
	D								
P03 XCB/XCN/XB/2XF R2-4 1 x EV XCB + EV XCN + EV XB + 2 x EV XF (8 outputs used)	A	Xcb LF	Xcn MB	Xcn HF	Xb LF	Xf MB	Xf HF	Xf MF	Xf HF
	B								
	C								
	D								
P04 XDS/XDS/2XB/2XF R2-4 2 x EV XDS + 2 x EV XB + 2 x EV XF (8 outputs used)	A			Xb LF	Xf MB	Xf HF			
	B						Xf LF	Xf MB	Xf HF
	C	Xds SUB	Xds SUB						
	D								
P05 XW12 – 4MIX R1-3 4 x EV XW12 12" Bi-amped (8 outputs used)	A	LF	HF						
	B			LF	HF				
	C					LF	HF		
	D							LF	HF
P06 XDS/XCB/XCN R2-4 2 x EV XDS + EV XCB + EV XCN (8 outputs used)	A			Xcb LF	Xcn MB	Xcn MF			
	B						Xcb LF	Xcn MB	Xcn MF
	C	Xds SUB	Xds SUB						
	D								
P07 XDS/XN R2-4 2 x XDS + EV XN (8 outputs used)	A			Xn LF	Xn MB	Xn HF			
	B						Xn LF	Xn MB	Xn HF
	C	Xds SUB	Xds SUB						
	D								



Factory Presets for X-Array Install (Xi) Series

Memory Identification	In	Out							
		1	2	3	4	5	6	7	8
P08 XI1122/85 4MIX R1-2 4 x EV XI1122/85 12" Bi-amped (8 outputs used)	A	LF	HF						
	B			LF	HF				
	C					LF	HF		
	D							LF	HF
P09 XI1122/85 & 1191 R1-2 2 x EV XI1122/85 12" plus EV 1191 Sub tri-amped (6 outputs used)	A	1191 SUB	1122 LF	1122 HF	FULL				
	B					1191 SUB	1122 LF	1122 HF	FULL
	C								
	D								
P10 XI1152/64 4-MIX R1-2 4 x EV XI1152/64 15" Bi-amped (8 outputs used)	A	LF	HF						
	B			LF	HF				
	C					LF	HF		
	D							LF	HF
P11 XI1152/64 & 1191 R1-2 2 x EV XI1152/64 15" plus EV 1191 Sub tri-amped (6 outputs used)	A	1191 SUB	1152 LF	1152 HF	FULL				
	B					1191 SUB	1152 LF	1152 HF	FULL
	C								
	D								
P12 XI1152/94 4-MIX R1-2 4 x EV XI1152/94 15" Bi-amped (8 outputs used)	A	LF	HF						
	B			LF	HF				
	C					LF	HF		
	D							LF	HF
P13 XI1152/94 & 1191 R1-2 2 x EV XI1152/94 15" plus EV 1191 Sub tri-amped (6 outputs used)	A	1191 SUB	1152 LF	1152 HF	FULL				
	B					1191 SUB	1152 LF	1152 HF	FULL
	C								
	D								
P14 XI1183/64 R1-2 2 x EV XI1183/64 18" Tri-amped (6 outputs used)	A	LF	MB	HF	FULL				
	B					LF	MB	HF	FULL
	C								
	D								
P15 XI1183/64 & 2181 R1-2 2 x EV XI1183/64 18" plus EV 2181 Sub Quad-amped (8 outputs used)	A	2181 SUB	1183 LF	1183 MB	1183 HF				
	B					2181 SUB	1183 LF	1183 MB	1183 HF
	C								
	D								
P16 XI1153/64 R1-2 2 x EV XI1153/64 15" Tri-amped (6 outputs used)	A	LF	MB	HF	FULL				
	B					LF	MB	HF	FULL
	C								
	D								
P17 XI1153/64 & 1191 R1-2 2 x EV XI1153/64 15" plus EV 1191 Sub Quad-amped (8 outputs used)	A	1191 SUB	1153 LF	1153 MB	1153 HF				
	B					1191 SUB	1153 LF	1153 MB	1153 HF
	C								
	D								



Technical Specification

Memory Identification	In	Out							
		1	2	3	4	5	6	7	8
P18 XI2153/64 R1-2 2 x EV XI2153/64 15" Tri-amped (6 outputs used)	A	LF	MB	HF	FULL				
	B					LF	MB	HF	FULL
	C								
	D								
P19 XI2153/64 & 1191 R1-2 2 x EV XI2153/64 15" plus EV 1191 Sub Quad-amped (8 outputs used)	A	1191 SUB	2153 LF	2153 MB	2153 HF				
	B					1191 SUB	2153 LF	2153 MB	2153 HF
	C								
	D								
P20 XI1123/106 R1-2 2 x EV XI1123/106 12" Tri-amped (6 outputs used)	A	LF	MB	HF	FULL				
	B					LF	MB	HF	FULL
	C								
	D								
P21 XI1123/106 & 1191 R1-2 2 x EV XI1123/106 15" plus EV 1191 Sub Quad-amped (8 outputs used)	A	1191 SUB	1123 LF	1123 MF	1123 HF				
	B					1191 SUB	1123 LF	1123 MF	1123 HF
	C								
	D								
P22 XI2123/106 R1-2 2 x EV XI2123/106 Tri-amped (6 outputs used)	A	LF	MB	HF	FULL				
	B					LF	MB	HF	FULL
	C								
	D								
P23 XI2123/106 & 1191 R1-2 2 x EV XI2123/64 15" plus EV 1191 Sub Quad-amped (8 outputs used)	A	1191 SUB	2123 LF	2123 MB	2123 HF				
	B					1191 SUB	2123 LF	2123 MB	2123 HF
	C								
	D								

Factory Presets for X-Line Series

Memory Identification	In	Out							
		1	2	3	4	5	6	7	8
P24 X-LINE 3W+S ODBU R2-7 X-line + Sub Array (8 outputs used)	A		Xxxx LF	Xfil MB	Xfil HF	Xvlt MB	Xvlt HF	Xvls MB	Xvls HF
	B	Xsub							
	C								
	D								
P25 X-LINE 3W+S 6DBU R2-7 X-line + Sub Array (8 outputs used)	A		Xxxx LF	Xfil MB	Xfil HF	Xvlt MB	Xvlt HF	Xvls MB	Xvls HF
	B	Xsub							
	C								
	D								